

#905
PAN AM - PAIRS

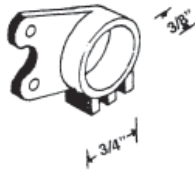

#906
TUCKER

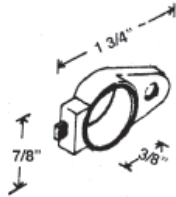

#907
SUPERIOR

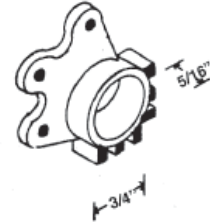

#910
KELLER - AIR CONTROL

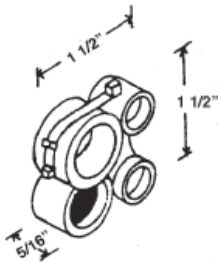

#911
AIR CONTROL #2

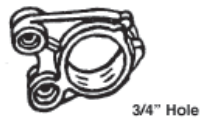

#912
TORQUE BEARING

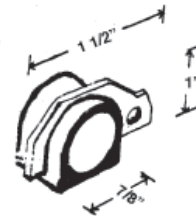

#913
P.G.T.

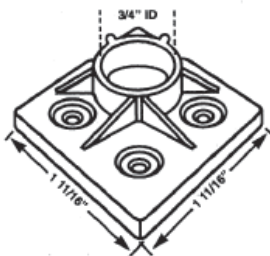

#915
AIRE LOK

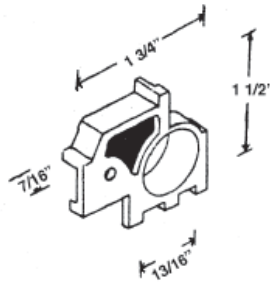

#916
LOOK - OLD

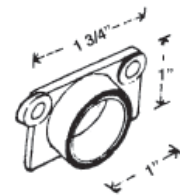

#917
YALE OGRON

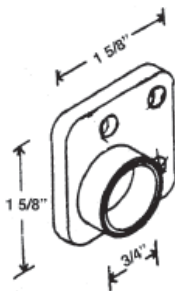

#921
CE - STANLEY

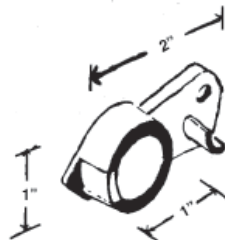

#922
HARCAR - NEW - PAIRS

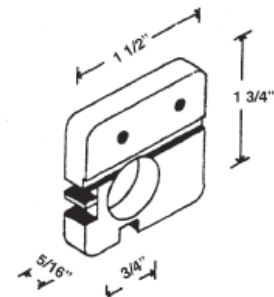

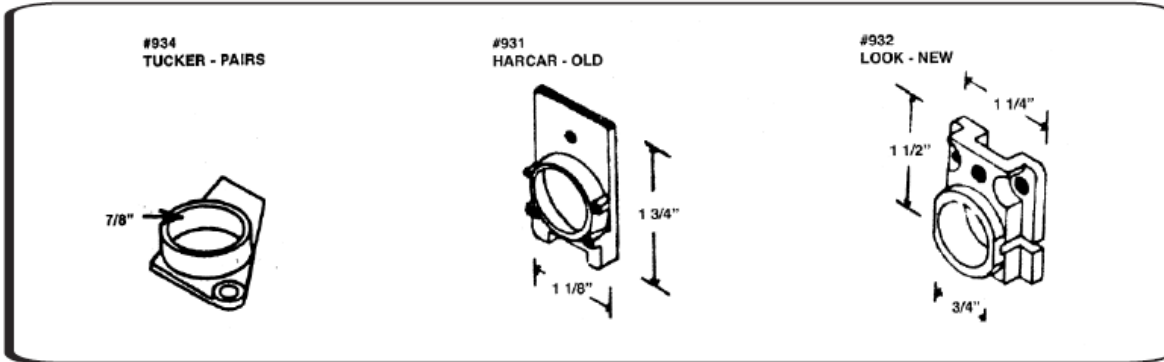

Bolts, Bushings, E-Rings, Screws

